

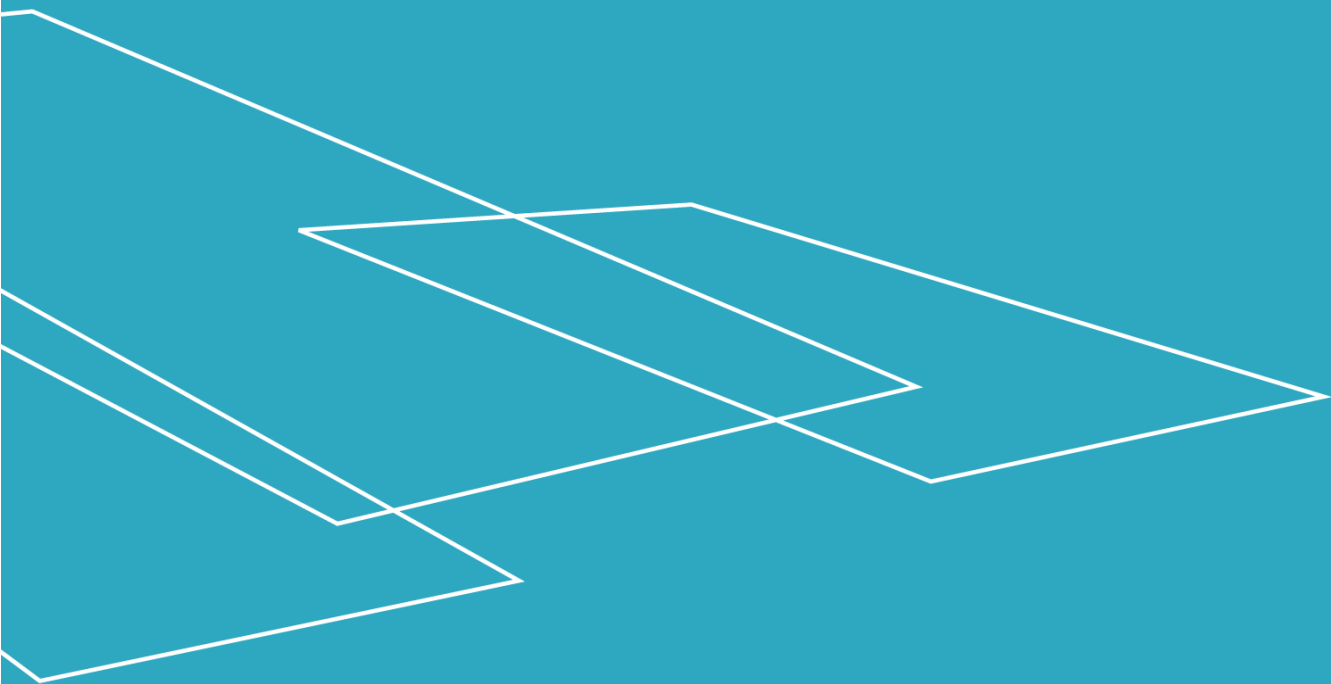

User Manual RAIZER® II

USER MANUAL – RAIZER® II – EN VERSION 05.02



Contents

1.	Foreword.....	4
1.1	Electronic version	4
2.	EU declaration of conformity.....	5
3.	Labelling of the equipment.....	6
4.	Terms of use.....	7
5.	Technical specifications.....	8
5.1	Dimensional drawings	8
5.2	Specifications.....	9
5.3	Specifications USB charger	9
5.4	Specifications charger.....	9
5.5	Specifications radio components.....	10
5.6	Patents and design registration.....	11
6.	Safety instructions.....	12
6.1	Avoid personal injury	12
6.2	Overload	12
6.3	Personal safety	12
6.4	Safety belt	12
6.5	Handling.....	13
7.	Functionality	14
8.	Prior to use.....	14
8.1	Charging the Raizer	14
8.2	Operating the Raizer	15
9.	Operation.....	17
9.1	Assembling the Raizer	17
9.2	Placing the Raizer	18
9.3	Mounting the seat belt.....	19
9.4	Mounting the backrests	20
9.5	Mounting the legs.....	21
9.6	Headrest.....	22
9.7	Alerts prior to lifting.....	23
9.8	Lifting a person	24
10.	Disassembly	26
11.	Charging the Raizer	27
12.	Maintenance.....	28
12.1	Cleaning.....	28



12.2 Mechanical maintenance – service inspections28

12.3 Maintenance of the transport bags28

12.4 Pairing the transmitter and the receiver (remote control)29

12.5 The remote control.....30

13. Service inspections.....31

14. Service logbook32

15. Spare parts and accessories33

16. Troubleshooting36

17. Electrical diagram.....37

18. Disposal38

19. Right of complaint.....38

October 2021



1. Foreword

Congratulations on your purchase of the Raizer.

This is an original user manual for your new Raizer II. Hereinafter we use the term Raizer for Raizer II, if nothing else is specifically indicated.



It is important to read this manual before using the Raizer.

The Raizer is a battery-powered mobile lifting chair which helps a lying person up to an almost standing position in a few minutes. The Raizer can be operated by only a single assistant and requires no physical effort from the assistant aside from a helping hand. The Raizer is simple to operate by means of the control panel mounted on the side of the seat, or with the remote control.



1.1 Electronic version

We offer an online version of the user manual which can always be accessed by scanning the below QR code or from our website:

<https://www.liftup.dk/en/products/accessories/raizer-quick-guides/>

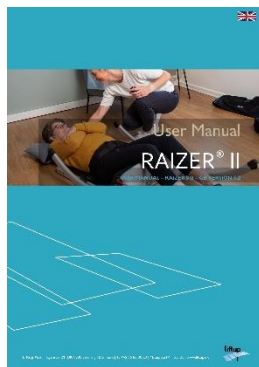

Scan to open or download the user manual



On our website we also offer some helpful videos which will provide you with information on alarms/signals and troubleshooting, assembly and disassembly of the Raizer: <https://www.liftup.dk/en/products/accessories/raizer-video-guide/>

Scan to go to online videos



2. EU declaration of conformity



EU declaration of conformity

EN version 02.01 Raizer® II

Manufacturer:	Liftup A/S	CE
Address:	Hagensvej 21, DK-9530 Støvring, Denmark	
Phone:	+45 9686 3020	
Reg. No.	523867 - Danish Medicines Agency	
SRN:	DK-MF-000007509	

hereby declares:

Equipment:	RAIZER® II Battery-powered mobile lifting chair which helps a lying person up to an almost standing position
Basic UDI-DI:	5714420RAIZERII5H
Year and serial number:	

The Raizer II is in compliance with:

	Regulation (EU) 2017/745 on medical devices class 1 (according to annex VIII of the Regulation (EU) 2017/745)
EMC Directive	2014/30/EU
ROHS Directive	2011/65/EU
Radio Equipment Directive (RED)	2014/53/EU

The above product is manufactured under the following management system:

EN ISO 9001: 2015	Quality management, Certificate No. 5749-3027770-01-02-01
-------------------	---

This EU declaration of conformity is issued under the sole responsibility of the manufacturer.

_____ CEO Position	_____ Søren Elisiussen Name
_____ Liftup A/S, Hagensvej 21, DK-9530 Støvring, Denmark Place	
_____ 26 May 2021 Date	_____  Signature

3. Labelling of the equipment

Insert copy of
CE certification mark here

4. Terms of use

The Raizer should only be used to bring a person lying on the floor to a seated or almost standing position, if the person is unable to do so by him-/herself. The person may require relocation from this position. A hygiene cover or a form of textile must be applied to the seat if the person to be lifted is NOT wearing clothes on areas in direct contact with the Raizer.

The max. load of the Raizer is stated on the CE mark on the rear of the seat. The Raizer can be used approx. 40 times at full load on a full charge. A charger is included with your Raizer.



Movable parts: Be careful not to get crushed. Service inspections must always be undertaken by a qualified service technician. The owner of the device is obliged to maintain it according to the maintenance guide in section 12. It is strictly forbidden to modify the product as this may endanger people's personal safety.



The Raizer's parts may be hot or cold to touch in case they have been stored in the baggage compartment of a car or in direct sunlight. Please consider this before using the device.



Lifting capacity: Max. 150 kg (330.7 lbs)



Do not push or transport the lifting chair while the person is sitting in it. The Raizer is not designed for transport of persons.



Do not stand on the lifting chair. The Raizer is not designed for transport of persons.



Never flush the lifting chair with water and never immerse it in water. General cleaning may only be done using a well-wrung cloth or sponge.



Read the user manual thoroughly before using the lifting chair



Do not dispose of batteries, electrical or electronic equipment with unsorted household rubbish. When disposing of this device, ensure compliance with local ordinances and regulations.

5. Technical specifications

5.1 Dimensional drawings

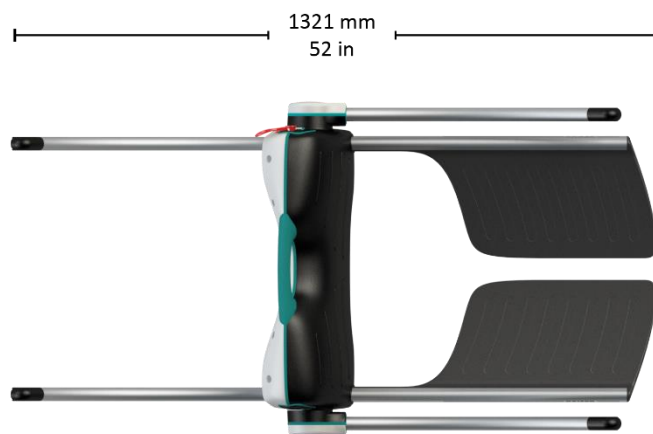
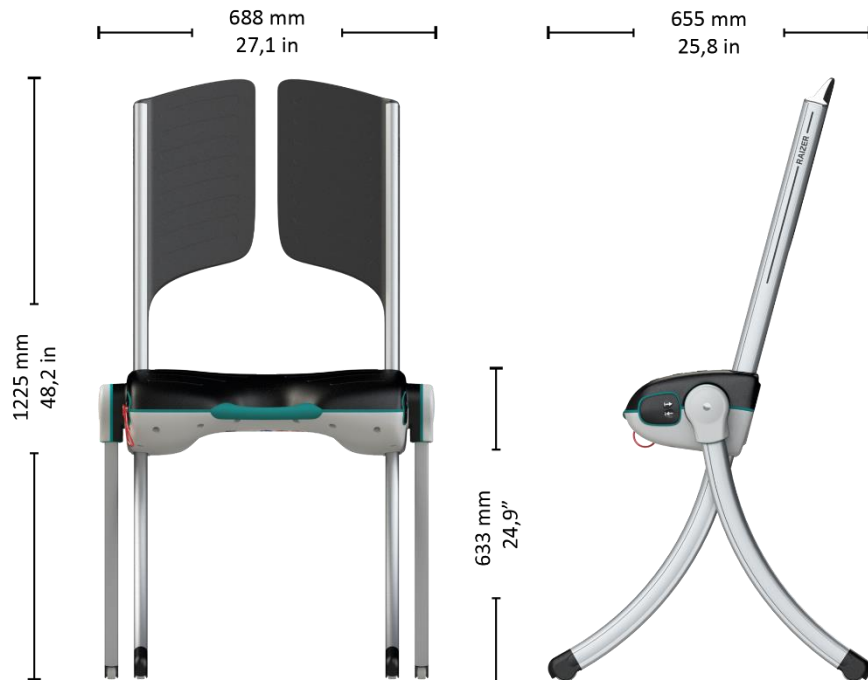

5.2 Specifications

Battery:	LiFePo4, 12V, 5AH
Number of lifts on full charge:	40 with a max. load. Approx. 80 with an average load
Duty cycle:	1 min. / 5 min.
Charging time:	Up to 6 hours with the provided charger
Charging of depleted battery:	10–15 min. = 1 lift
Dimensions (L x W x H):	Standing 655 x 688 x 1225 mm/25,8 x 27,1 x 48,2 in Lying 1321 x 688 x 277 mm / 52 x 27,1 x 10,9 in
Weight:	Motor unit/seat 9.2 kg/20.3 lbs – Backrest and legs 4.9 kg/10.8 lbs = total 14.1 kg/31.1 lbs
Lifting capacity:	Max. 150 kg/330.7 lbs
Lifting time:	20-30 sec.
Noise level:	< 70 dB A
Dust and water	IP 52 (protected from limited dust ingress; protected from water spray)
Operating forces of controls:	< 3N (300g)
Working temperature:	+5°C to +40°C/41°F to 104°F
Storage temperature:	-25°C to +70°C/13°F to 158°F
Materials:	Motor unit/seat: PolyCarbonate + ABS Backrests: PolyCarbonate + ABS - Legs: Aluminium

The Raizer meets the relevant requirements notably in following standards:

EN/ISO 10535:2007	Hoists for the transfer of disabled persons. Confirmed by Danish Technological Institute, certificate no. 222
EN 12182:2012	Assistive products for persons with disability - General requirements and test methods
EN 60601-1:2006+Corr-1,-2:2008 +AC, A1:2013	Medical electrical equipment – Part 1
EN 60601-1-11:2015	Requirements for medical electrical equipment and medical electrical systems used in the home healthcare environment

5.3 Specifications USB charger

USB Type A	Min. 5Volt 1 Ampere
------------	---------------------

5.4 Specifications charger

Type 2241 4-cell LiFePO4 charger	
Input Volt:	100-240V nom. Min. Max. 90-264 VAC
Power:	Max 15W
Output Volt:	14,6V
Dimensions (L x W x H):	120 x 47 x 70mm / 4,8 x 1,85 x 2,75 in.
Weight:	170 g (0,38 lbs.)
Working temperature:	+5°C to +40°C/ 41°F to 104°F
Storage temperature:	-25°C to +70°C / 13°F to 158°F
Dust and water:	IP 4x
Expected service life:	>5 years

5.5 Specifications radio components

All radio components comply with the following standards:

EU2014/53/EU,	Radio Equipment Directive (RED)
FCC (USA)	CFR 47 Part 15
ISED (Industry Canada)	RSS-210
EN 62479:2010	Assessment of the compliance of low power electronic and electrical equipment with the basic restrictions related to human exposure to electromagnetic fields (10 MHz to 300 GHz)
EN 300 440, v2.1.1	Electromagnetic compatibility + Radio spectrum Matters
BS EN 60601-1-2:2015	Medical electrical equipment - Part 1-2: Electromagnetic disturbances
CISPR 11, Class B	Emission
BS EN 61000-4-2:2009	EMC - Testing and measurement techniques. Electrostatic discharge immunity test
EN 61000-4-3:2006+A1:2008+IS1:2009+A2:2010	EMC - Radiated, RF, electromagnetic field immunity test
EN 61000-4-8:2010	EMC - Power frequency magnetic field immunity test
AS/NZS 4268	Radio Equipment and Systems –Short Range devices
AS/NZS 2772.2	Radio Frequency Fields (mean power < 1 mW)

MODULE1:

2,4GHz Short Range device	Receiver Class 3; FCC ID:2AK8H-MODULE1
Dimensions (L x W x H):	72 x 33 x 10mm / 2,83 x 1,30 x 0,40 in.
Weight:	10 g (0,035 lbs.)
Frequencies:	2,410GHz 2,435GHz and 2,460GHz
Duty cycle:	< 1%(only TX for pairing Remotes)
Power:	< 0,6mW Controlled environment
Supply:	5,6 Volt 30mA
Dust and water:	IP 52 (protected from limited dust ingress; protected from water spray)
Working temperature:	+5°C to +40°C / 41°F to 104°F
Storage temperature:	-25°C to +70°C / 13°F to 158°F
Expected service life:	>5 years

Handheld REMOTE1:

2,4GHz Short Range device	Receiver Class 3; FCC ID:2AK8H-REMOTE1
Dimensions (L x W x H):	80 x 60 x 21mm / 3,15 x 2,36 x 0,82 in.
Weight:	47 g (0,10 lbs.)
Frequencies:	2,410GHz 2,435GHz and 2,460GHz
Duty cycle:	<1%
Power:	<0,6mW Controlled environment, Hold to run
Battery:	3 Volt CR2032
Dust and water:	IP 42
Operating forces of controls	< 3N (300g)
Working temperature:	+5°C to +40°C / 41°F to 104°F
Storage temperature:	-25°C to +70°C / 13°F to 158°F
Expected service life:	>5 years

We reserve the right to make technical modifications

5.6 Patents and design registration



The following patents apply to the product:

- EP2911637
- PCT/DK2015/050041
- US 09561144
- US 09980866
- US-2018-0042791-A1
- 52936AU01



The product is protected by the following design registrations:

- D55542EU01
- DM/087 953

6. Safety instructions

6.1 Avoid personal injury



Even though the Raizer comes fitted with various safety features, never use it if persons or animals unintendedly are close by, as this may lead to the risk of crushing. **Never allow children to play with the Raizer.**

6.2 Overload

In order to avoid damage to the device in the event of overload (max. 150 kg/330.7 lbs), the Raizer is fitted with an overload cutout, which when triggered halts the lifting chair and issues an audible alarm. In the event of overload, run the chair down to the horizontal position/floor level.

For safety reasons the Raizer is designed to sink slowly under heavy loads which is completely normal. This feature has been introduced in order to avoid mechanical breakage in the event of overload.

6.3 Personal safety

- To avoid personal injury, it is NOT permitted to use the lifting chair when someone or something is at risk of being injured by crushing, cutting, falling, slipping, or similar.
- It is important that the assistant ensures that the chair can move without putting anyone or anything at risk.
- Be extra careful when there are children and physically or mentally challenged people on or near the chair, as these groups cannot always be expected to be able to foresee the possible consequences of its movements.
- Never load more on the chair than the 150 kg (330.7 lbs) stated on the loading sign as the maximum load.
- Our recommendation is to never use the lifting chair if the person is not secured with the seat-fitted safety belt.

6.4 Safety belt

- The Raizer is fitted with a safety belt when delivered. The safety belt will help to keep the person in position during the lift. It is not necessary to use the safety belt, but we recommend it. The safety belt offers safety and security to the person during the lift.
- However, it is important to note that the safety belt is not meant to support the person 100 %. This means that in case the person is unable to keep the upper body/torso in an upright position, you should use a breast belt or several safety belts (optional equipment)

6.5 Handling

The Raizer will normally be supplied by your dealer. The lifting chair is ready for use upon delivery.

The Raizer can be transported in the 2 provided bags.



One is a protective cover for the seat itself. The seat is carried in the turquoise handle.



The backrest and legs are carried in the bag by using carrying straps for hand or back (long strap for shoulders or two straps as a backpack).

Do not subject the Raizer to severe knocks or blows as this can affect product functionality.

Keep the accompanying remote control dry and do not subject it to severe blows, such as by throwing it or dropping it, etc. Cleaning may only be done using a well-wrung cloth.



NEVER use a high-pressure jet or running water to rinse the chair and **NEVER** immerse it in water, as this can damage the product.

7. Functionality

The Raizer is a battery-powered mobile lifting chair which raises a fallen person up to an almost standing position in a few minutes. It can be operated by only a single assistant and requires no physical effort from the assistant aside from a helping hand.

The lifting chair works by the assistant assembling the Raizer around the fallen person and is operated by using the control panel on the seat or by means of the remote control. The assistant can raise the fallen person to a sitting or almost standing position ready for relocation.

To use the Raizer, hold down the button for the entire lift. The lifting will stop if the button is released.

8. Prior to use



Make sure that the Raizer is always fully charged. A charger and an adapter cable for USB charging are supplied with the device, and we recommend that the Raizer always be charged and ready for use. You should check the Raizer for power at least once every 6 months and recharge if necessary. See also section 11.

8.1 Charging the Raizer

The Raizer must be charged for at least 6 hours prior to its first-time use, as required and as a minimum every 6 months with the provided charger).

It is advisable to check the battery indicator on the side of the lifting chair to verify the level of the charger.

Charging may also be done using the USB cable; however, this takes considerably longer than with the charger (approx. 20 hours for a full charge).

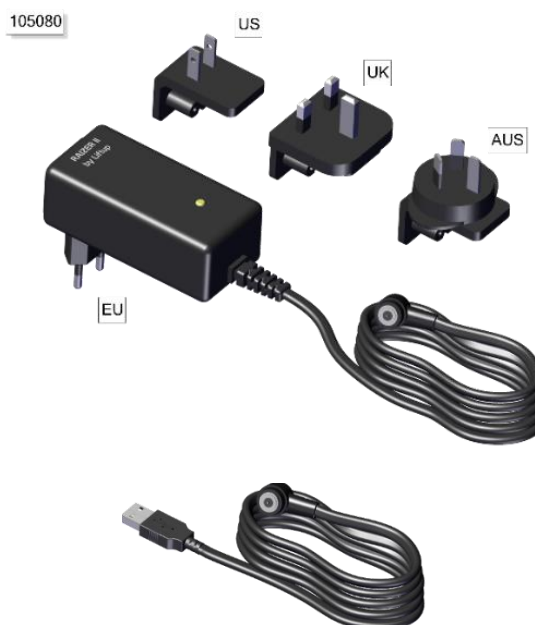

Check that the chair is charged prior to use. The battery indicator must not flash red.

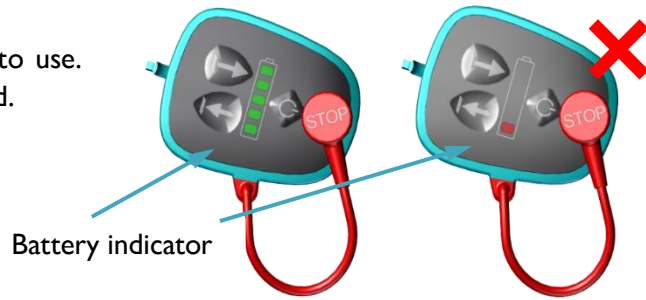

The Raizer can be stored anywhere you like. However, lifting speed will be reduced if the battery temperature falls below 0°C. In practice, though, if charged, the Raizer will always be able to perform its task, even if stored in a vehicle in a severe frost (-15°C). However, you must bear in mind that components which are either very hot or cold, may be uncomfortable to touch.

8.2 Operating the Raizer

The control panel is situated on the right side of the seat.

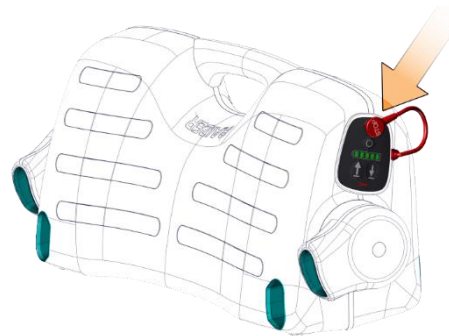

To turn on the Raizer, press the on/off button or the UP/DOWN arrow keys on the side of the chair. Check that the chair is charged prior to use. The battery indicator must not flash red.

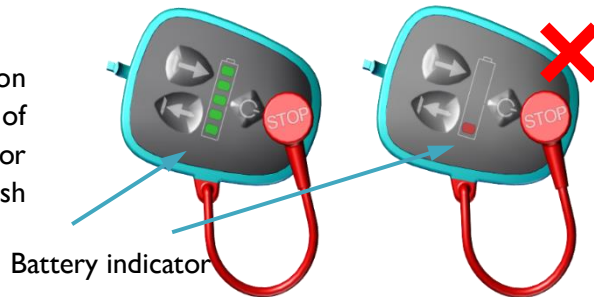

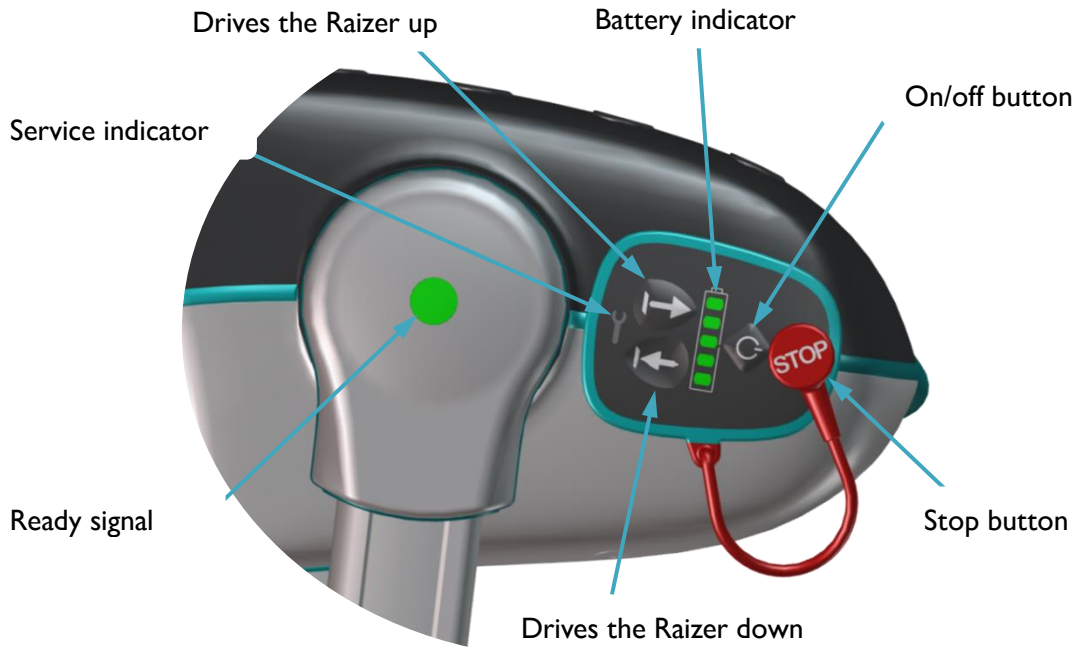

The remote control

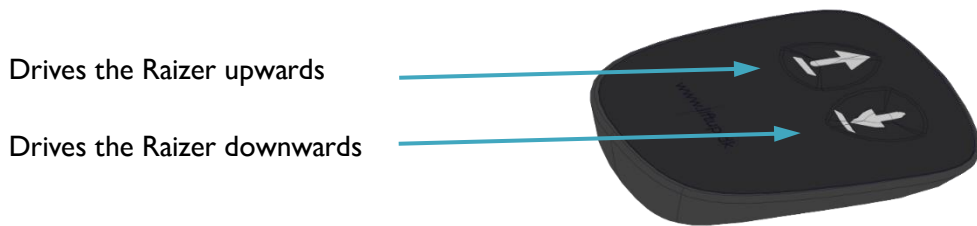

The remote control is placed in a pocket on the side of the seat and fixed with a magnet. It is released with a light push to the upper part of the remote control.

BE CAREFUL not to lose the remote control when releasing it from the Raizer.

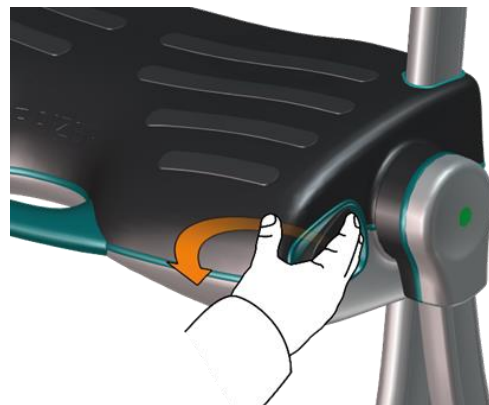
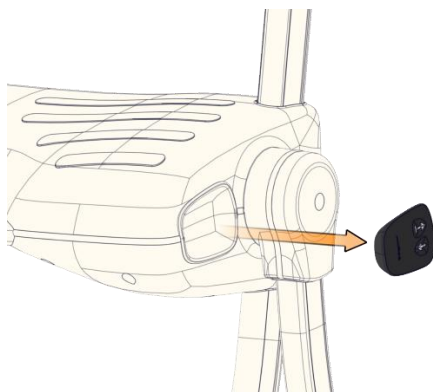

1. Press the UP arrow (↑) to drive the lifting chair upwards.

The Raizer will only run for as long as the button is activated.

NOTE:

The Raizer must be turned on for the remote control to work (by a light push of the on/off button on the side of the chair).

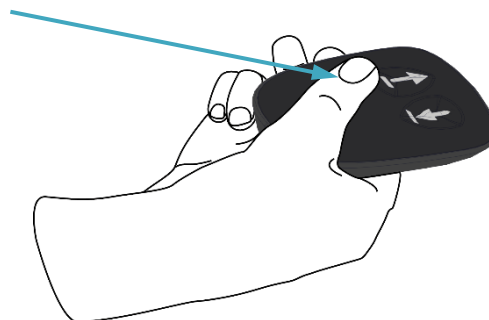

2. The stop button is activated when it is required to stop any movement of the Raizer. Pull the button or the cord to release the button from its position.

The Raizer can only be reactivated when the stop button has been remounted.

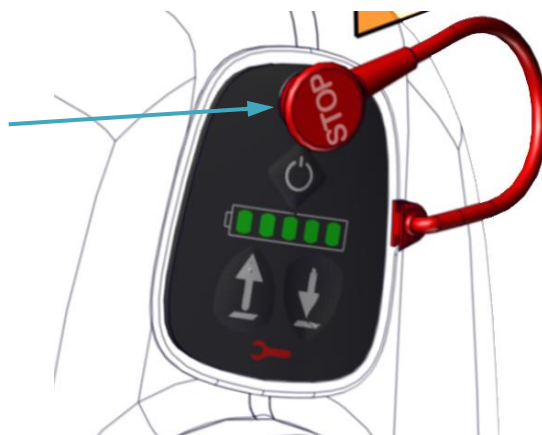

9. Operation

9.1 Assembling the Raizer



On our website we offer some helpful videos which will provide you with information on alarms/signals and troubleshooting, assembly and disassembly of the Raizer:

<https://www.liftup.dk/en/products/accessories/raizer-video-guide/>



IMPORTANT!

Please observe that the backrest should be attached at first. If the legs are attached at first, it will disturb the fitting of the backrest. Fit one side at a time.



Correct assembly
(first mount the backrest)



Incorrect assembly
(do NOT mount the legs at first)

9.2 Placing the Raizer

1. Arrival and approach.

You may place a pillow under the person's head for better comfort.

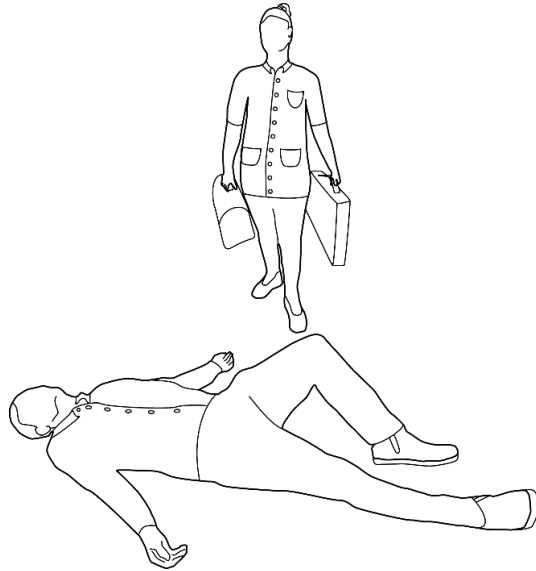

2. Place the seat on the floor next to the lying person. The person must lie on the back.

Lift the thighs to an angle.
Carefully push the seat under the thighs.

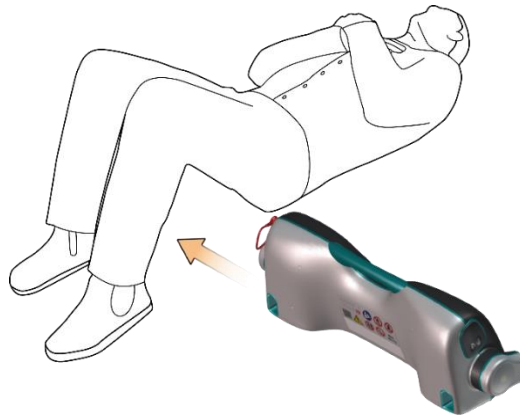

NOTE!

Always attach the backrest at first. If the legs are attached at first, it will disturb the fitting of the backrest.

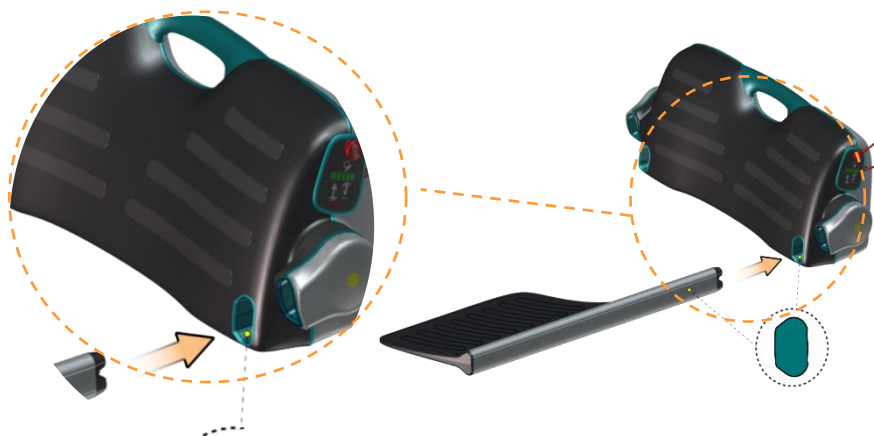

Take care that the backrest is attached into the correct hole

9.3 Mounting the seat belt

1. If the seat belt has not already been fitted on the backrest, mount it by pushing the fitting downwards over the backrest profile with a sliding movement. The fitting can be mounted from both ends (see illustrations).

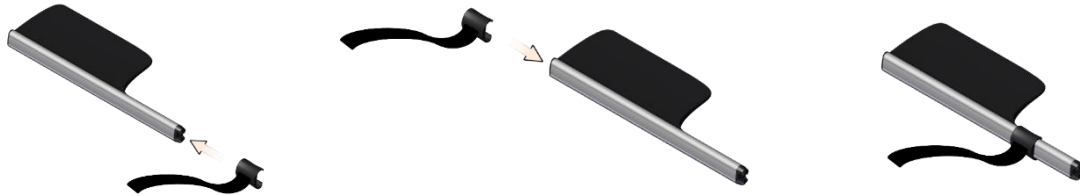

2. Fasten the seat belt. A distinct click will be heard.

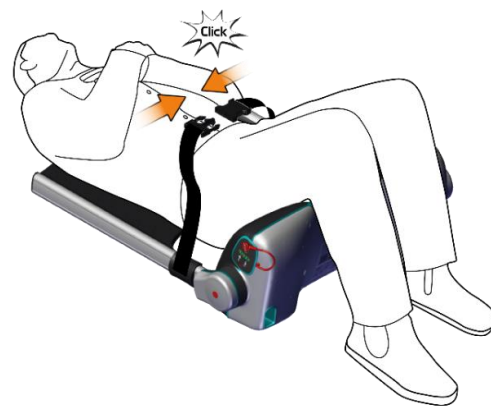

3. **WARNING!** Never lead the seat belt under the rear legs of the Raizer, as this may cause the person to be crushed. (The seat belt clip however will break off before any personal damage).

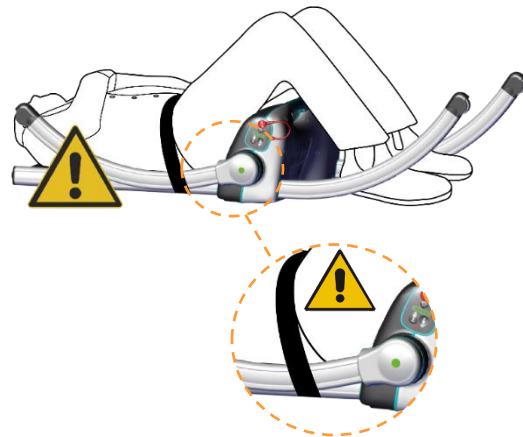

9.4 Mounting the backrests

Left backrest

1. Lift the person carefully by the shoulder, with a light push to the elbow. Push the backrest carefully under the shoulder of the person.

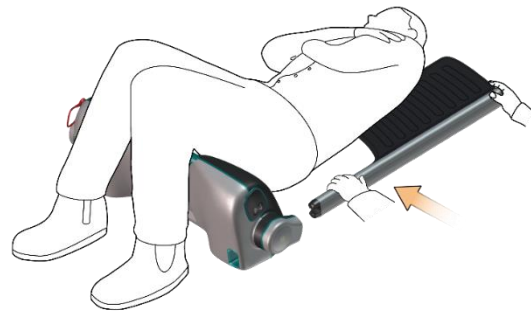

2. Click the backrest into place in the seat with a sliding movement. If necessary, place your foot in front of the seat to stop it from slipping forward. A confirmation tone will sound, when the backrest has been correctly fitted (🎵).

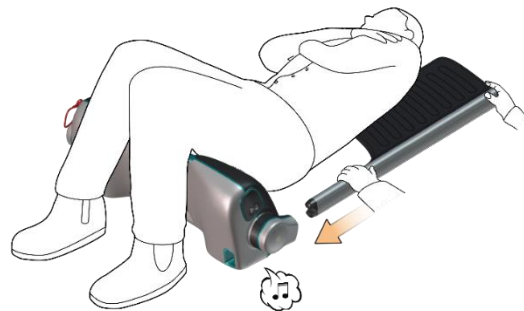

Right backrest

1. Lift the person carefully by the shoulder, with a light push to the elbow. Push the backrest carefully under the shoulder of the person.

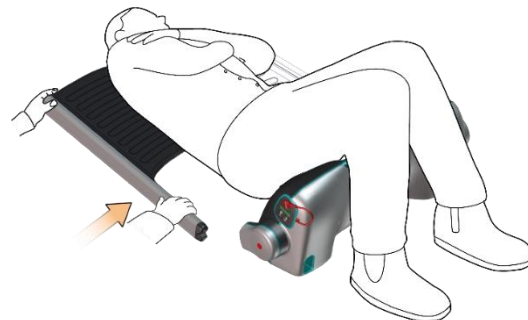

2. Click the backrest into place in the seat with a sliding movement. If necessary, place your foot in front of the seat to stop it from slipping forward. A confirmation tone will sound, when the backrest has been correctly fitted (🎵).

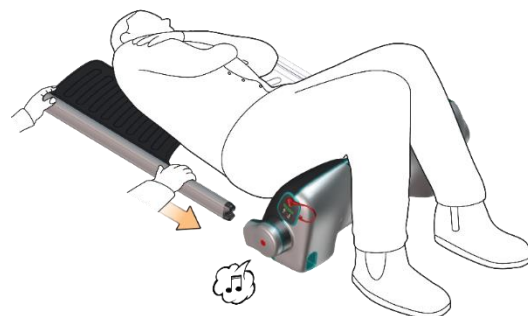

9.5 Mounting the legs



NOTE! All 4 legs are identical and may be fitted in any sequence

Left rear leg

Insert the leg carefully, until it clicks into place. A confirmation tone will sound when the leg has been correctly fitted (🎵).

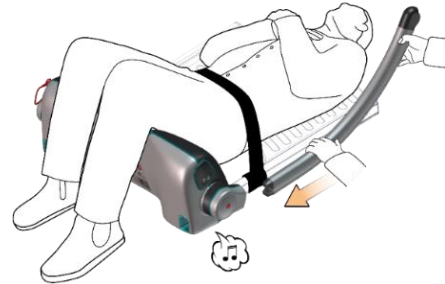

Left front leg

Insert the leg carefully, until it clicks into place. A confirmation tone will sound when the leg has been correctly fitted (🎵).

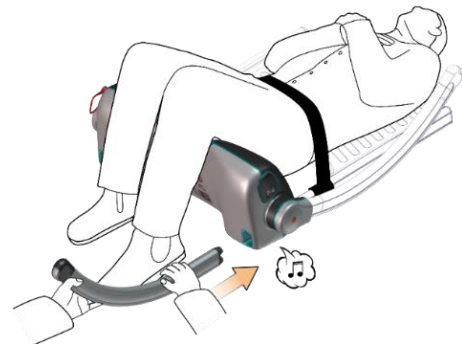

Right rear leg

Insert the leg carefully, until it clicks into place. A confirmation tone will sound when the leg has been correctly fitted (🎵).



Right front leg

Insert the leg carefully, until it clicks into place. A double confirmation tone will sound when the last leg has been correctly fitted (🎵 🎵).

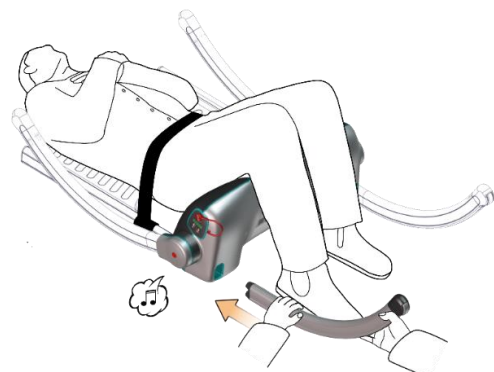

Ready signal

When all 4 legs have been fitted correctly, a double confirmation tone will follow (♪ ♪).



The double alert signifies that the Raizer is ready to lift a person.

The LED light on the side of the Raizer now changes from yellow to green to demonstrate that the Raizer is ready for operation.



9.6 Headrest

We recommend supporting the neck and head of the person to be lifted as it may be hard to keep the head upright during the lift. In most cases, in connection with the Raizer II lifting chair, we recommend that the helper supports the person's neck with one hand during the lifting process while simultaneously operating the remote control with the other hand.

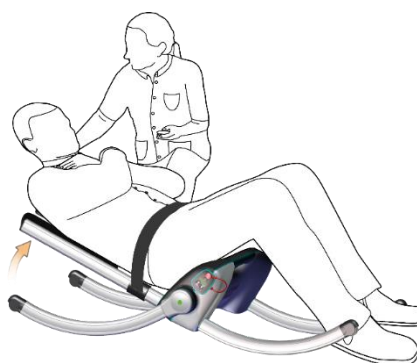

However, in cases where it is necessary or practical for the helper to have both hands free, a headrest* may be a great help.

To apply the headrest, push it under the neck of the lying person so that it slides between the two backrests.

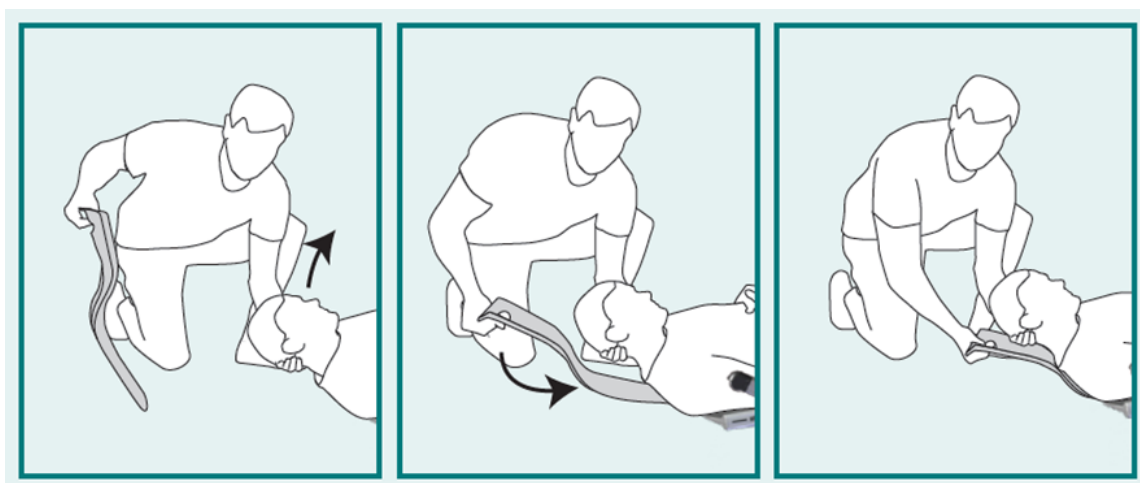

*Supplementary equipment

9.7 Alerts prior to lifting

Positioning the person

Make sure that the shoulders of the person are placed suitably on the Raizer and that the arms are crossed over the chest, as the rear legs will move downwards towards the floor as soon as the UP arrow (↑) is pressed and may hit the person should shoulder/arms be in the way.

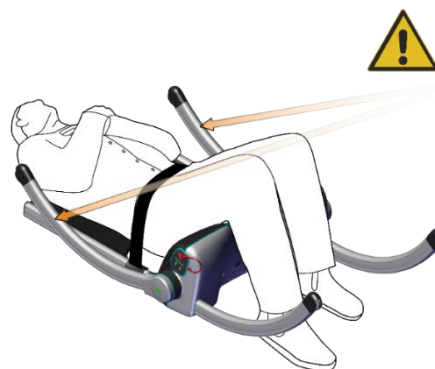

Rear legs

Please watch out for a potential crushing between the rear legs and the floor. Make sure to keep hands and feet at a safe distance from the movement of the legs.



Front legs

Take care that the person's legs are together and that feet/legs are not at risk of getting in under a front leg when the chair is raised, as the front legs move toward the floor before the chair begins to lift the person.



DO NOT run the chair up before you have made sure that the person's feet, arms, hands and other extremities will not be endangered by the movements of the lifting chair.!

9.8 Lifting a person

1. The Raizer is operated by using the control panel on the seat or by means of the remote control.

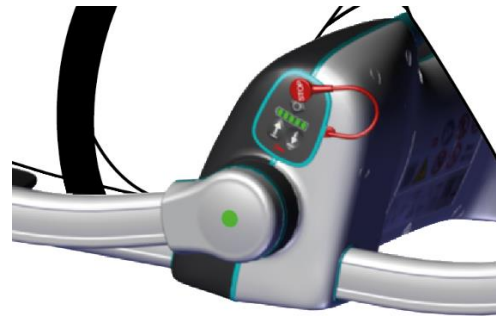

2. The remote control is placed in a pocket on the side of the seat and fixed with a magnet. It is released with a light push to the upper part of the remote control.

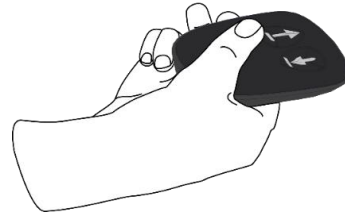

BE CAREFUL not to lose the remote control when releasing it from the Raizer (cf. section 8.2).

3. The Raizer is now ready to lift the person. Before initiating the lift, make sure that the person is ready, and give a warning that the lift will begin.

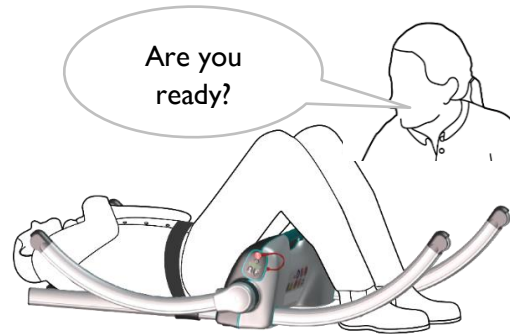

4. Support the neck of the person with one hand or apply a headrest*. Press the “UP arrow” (↑) on the side panel or the remote control.

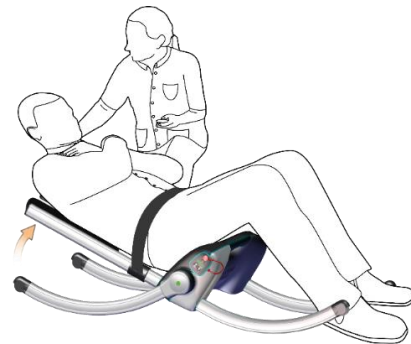

* Supplementary equipment

5. Press the UP arrow (↑) until the person has reached the requested position.

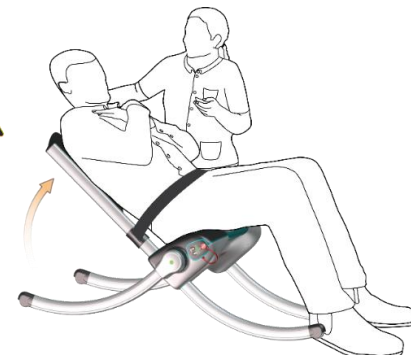

6. The Raizer will automatically stop when reaching its top position and the person is in an upright sitting position.

NOTE:

The Raizer is safeguarded against running too high and therefore stops automatically in its top position. A confirmation tone will sound (♫), indicating that the Raizer has reached its top position.

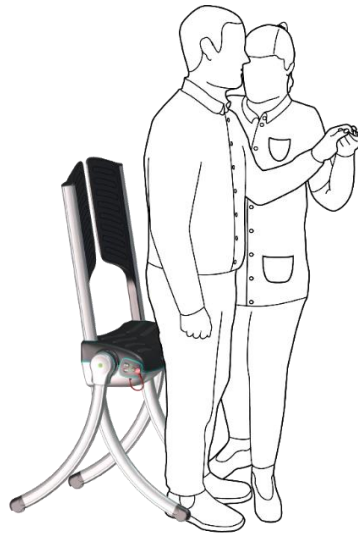

NEVER push the Raizer when a person is sitting on it. The wheels of the legs are only meant to avoid scratches to the floor in connection with the lifting procedure.

The Raizer is not designed for transport of persons.



10. Disassembly



IMPORTANT! Always run the Raizer to the horizontal position prior to disassembly (otherwise the next assembly of the Raizer will be upset).

When the Raizer has been run into the horizontal position and is ready for disassembly, place the remote control in its pocket at the side of the seat. If all legs are dismantled and the remote control has not been put back into its pocket, the Raizer will begin to ‘call out’ for the remote control with a warning tone (a vibrant tone). As soon as the remote control is in place, the warning tone will cease.

Always run the Raizer to the horizontal position (until it stops with a distinct sound), prior to disassembly (otherwise the next assembly of the Raizer will be upset).



The Raizer is disassembled by pulling all legs (4) and backrests (2) out.

Do not forget to place the remote control in its pocket, as otherwise a vibrant warning tone will sound when all legs have been dismantled.

When the Raizer has been disassembled, all parts are stowed away in the transport bag.



11. Charging the Raizer

The battery indicator (LED) lights green when the battery is fully charged.

The battery indicator (LED) flashes red to show that the battery capacity is below 10% and the Raizer must be recharged.

NOTE:

The indicator only lights up when the lifting chair is turned on.

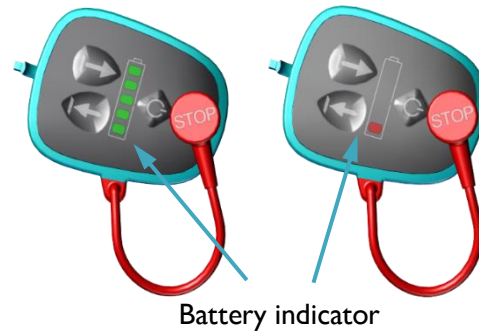

Battery indicator

The charger socket is situated in the same place as the red stop button.

1. Remove the stop button and plug the charger cable into the socket. The plug is mounted with a magnet and will snap into place by itself.

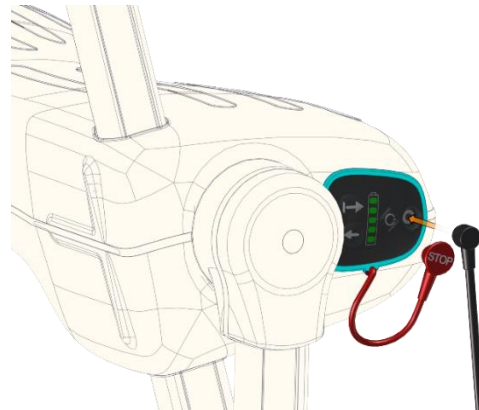

2. Connect the provided charger to the socket on the Raizer.

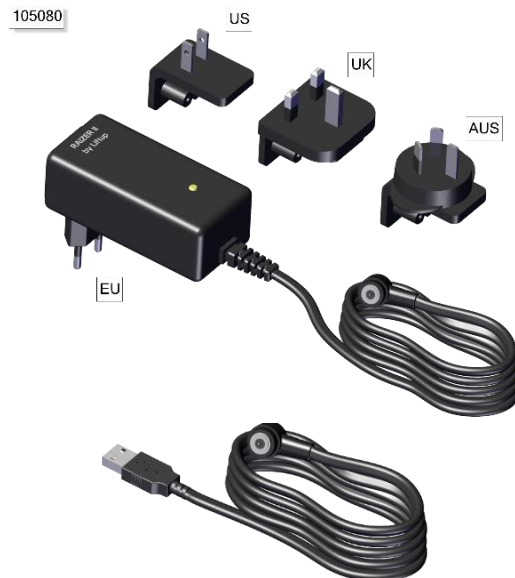

Or use the provided USB cable.

NOTE: Charging with the USB cable takes considerably longer than with the charger.



The Raizer must be charged for at least 6 hours prior to its first-time use, as required and as a minimum every 6 months (with the provided charger). Approx. 10-15 minutes' charging is sufficient for 1 lift. A full charge gives approx. 40 lifts at room temperature. The number of lifts will be reduced at lower temperatures.

12. Maintenance

12.1 Cleaning

 **IMPORTANT!** General cleaning may only be done using a well-wrung cloth or sponge.

The Raizer is **NOT** waterproof and therefore must not be immersed in water or flushed with running water. It is however acceptable to clean the Raizer with a damp cloth.



The Raizer must NOT be flushed with water



The Raizer must NOT be immersed in water

You can disinfect your Raizer by using the below disinfectants recommended:

Hydrogen Peroxide Aq.	1,0% (max.) (diluted hydrogen peroxide)
Ethanol based products	70-85 v/v%. alcohol
Soap solutions	PH value max. 9



NEVER use a high-pressure cleaner or other power flushing or running water, as this may cause permanent damage to the lifting chair.

12.2 Mechanical maintenance

The mechanical maintenance of the Raizer shall normally only be undertaken in connection with the regular annual service inspection. This is to be undertaken by a qualified service technician in accordance with section 13.

Should unexpected errors or unusual sounds occur, contact your dealer at once.

12.3 Maintenance of the transport bags

The provided transport bags may be cleaned with a well-wrung cloth or in the washing machine at max. 30°C. You can disinfect the bags by using alcohol-based disinfectants at a concentration of 70–85 v/v%.



Wash at max. 30 C°



No tumble drying



No ironing



No bleach

12.4 Pairing the transmitter and the receiver (remote control)

1. The Raizer battery must be fully charged, see section 11.
2. The Raizer must be switched off either using the on/off button or await the Raizer switching off automatically after 10 minutes without activity.
3. Press the UP (↑) and DOWN (↓) arrows of the remote control at the same time and keep them pressed for approx. 5 seconds until the control LED on the remote control begins to flash slowly. The remote control is now in installation mode for 2 minutes.
4. Within these 2 minutes, switch on the lifting chair you require paired/associated with the remote control by pressing the UP/DOWN (↑/↓) arrows on the side of the chair simultaneously.
5. The control LED on the remote control is paired/associated with the lifting chair when it stops flashing.
6. Test the system to make sure that the pairing has been performed correctly; if not, repeat steps 1-5 above.

Resetting the transmitter and the receiver:

To reset a remote control so that it is no longer paired/associated with the Raizer, do the following:

1. Press the UP (↑) and DOWN (↓) arrows at the same time and keep them pressed down for approx. 5 seconds until the control LED begins to flash slowly. The remote control is now in installation mode for 2 minutes.
2. Within the 2 minutes, perform the following sequence:

Press: UP (↑), UP (↑), DOWN (↓), DOWN (↓), UP (↑), DOWN (↓), UP (↑), DOWN (↓)

When the control LED starts to flash quickly, the remote control is no longer associated/paired with the Raizer.

Alternatively:

If the remote control is open, you may push “reset” to restore the initial state.



12.5 The remote control

A CR2032 battery is installed in the remote control.



In order to ensure reliable function, swap the battery every 2 years



BE CAREFUL not to swallow the coin cell



Keep batteries out of reach of small children. Should a child swallow a battery, consult a physician immediately



Do not dispose of batteries, electrical or electronic equipment with unsorted household rubbish. When disposing of this device, ensure compliance with local ordinances and regulations.

Replacing the remote control battery:

1. Loosen the screw (Torx TX 6) on the rear of the remote control.
2. Remove the back panel
3. Swap the battery
4. Refit the back panel and make sure that the remote control is working correctly.

CR2032 Lithium Battery 3V

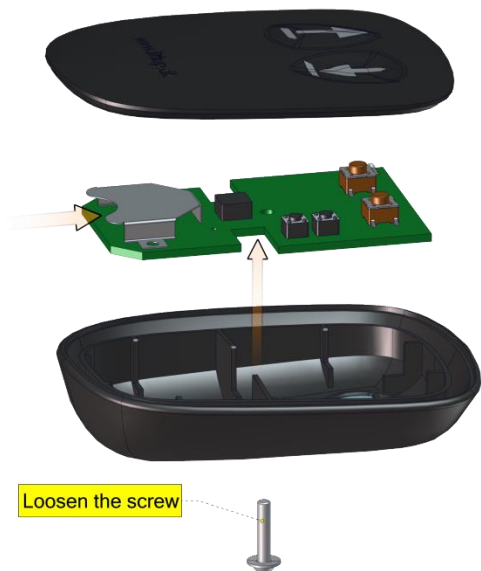

13. Service inspections

Under normal conditions of operation, a service life of >5 years may be expected, provided that the product is maintained in accordance with the guidelines of the producer. In addition to the general maintenance described in section 12, we recommend routine annual inspections (+/- one month) performed by a qualified service technician.

For models with the automatic service indicator activated, the Raizer will begin to flash a service message when it is time for the service inspection. Also, an acoustic alarm (🔊) will sound to remind you that service is due.

In case the automatic service indicator has been deactivated, a label on the product will inform you accordingly, and service intervals may be arranged with the local dealer at your discretion.

The dealer you have bought the Raizer from will offer this service, but if you wish to use another service provider, you as the owner of the Raizer are responsible for ensuring that the chosen service technician is suitably qualified in the product in question.

<https://www.liftup.dk/en/distributors/>



For safety reasons it is very important that these inspections are maintained, since lacking or improperly performed inspections may result in personal injury.

All service inspections performed must be logged in the service logbook, cf. the example in section 14.



14. Service logbook



Service logbook Raizer II

This form shall be filled in after every inspection. Keep the logbook near the Raizer.

Customer:	Product:
Address:	Serial No.:
Postal code/city:	Date of delivery:
Phone:	
Contact person:	Phone:





No.	Date	Comments	Signature
1			
2			
3			
4			
5			
6			
7			
8			
9			
10			
12			
13			
14			
15			
16			
17			
18			
19			
20			

15. Spare parts and accessories

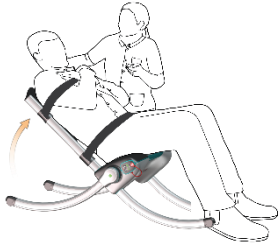

IMPORTANT! It is important to use only original spare parts. Replacement of parts may only be undertaken by a qualified service technician. The use of non-original spare parts may void the right of complaint. Furthermore, product safety may be compromised, which may pose a risk to personal safety.

For further details regarding spare parts and service, please contact one of our dealers at <https://www.liftup.dk/en/distributors/#>.

Part no.	Description	Photo/illustration
107464	Headrest	
104871	Leg (4 pcs. for a complete unit)	
104862	Backrest (2 pcs. for a complete unit)	
107250	Safety belt	
105026	Remote Control	

Part no.	Description	Photo/illustration
105192	Battery charger, 15W, Magnetic Male	
105082	Charger Cable USB	
107463	Carry case (including quick guides)	
107240	Cover for seat	
107693	Wall bracket (Optional equipment)	

Part no.	Description	Photo/illustration
107273	Trolley (Optional equipment)	
107374	Clip and belt	
104913	Hanger for trolley	
103314	Triple wheel for trolley, 2 pcs. (Optional equipment)	
103313	Bike bracket kit, trolley (Optional equipment)	
103741	Disposable hygiene cover (10 pcs.) (Optional equipment)	
102890	Battery 12V 5Ah LiFePo4 Raizer	

Part no.	Description	Photo/illustration
107230	Stop device for Raizer II	

16. Troubleshooting



On our website we offer some helpful videos which will provide you with information on alarms/signals and troubleshooting, assembly and disassembly of the Raizer:

<https://www.liftup.dk/en/products/accessories/raizer-video-guide/>



17. Electrical diagram

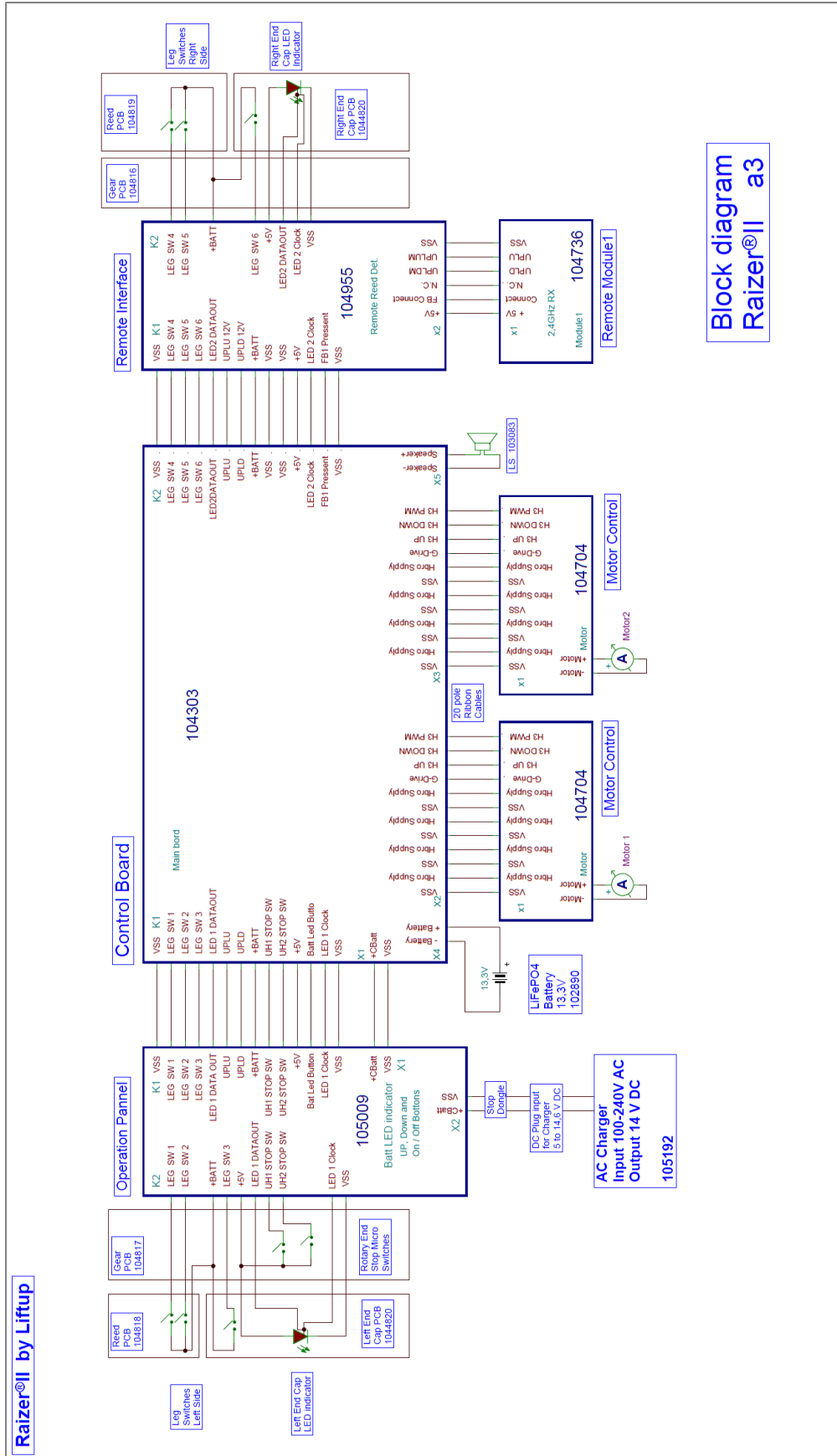

Block diagram Raizer® II a3

Raizer® II by Liftup

18. Disposal

It is the duty of the owner to dispose of the product in accordance with the regulations applicable at the time. Please note that the control unit and remote control contain batteries, which must be disposed of separately.



NOTE:

Do not dispose of batteries or electrical or electronic equipment with unsorted household rubbish. When disposing of this device, ensure compliance with local ordinances and regulations.

Consider contacting your dealer for assistance with disposal.

19. Right of complaint

The right of complaint encompasses the at any time applicable rules regarding the right of complaint.

Liftup offers full right of complaint on spare parts for two years provided the product is registered with Liftup (<http://lpr.liftup.dk/>).

Product Registration

Register your product today and receive 2-years liability for defect on your product directly from Liftup.

Product Id	<input type="text"/>
Name	<input type="text"/>
Address	<input type="text"/>
City	<input type="text"/>
Region / State	<input type="text"/>
Zip Code	<input type="text"/>
Phone	+ 1 <input type="text"/>
Email	<input type="text"/>
Copy of receipt	<input type="button" value="Vælg fil"/> Der er ikke valgt nogen fil

If you want to stay updated regarding the latest news and updates, please fill in the check box.



Please read more about this in the terms of sale and delivery:

<https://www.liftup.dk/en/about-liftup/general-conditions/>



NOTE: If the prescribed service inspections are not maintained, the right of complaint may be lost.

Failing to perform these inspections can also have serious consequences for product safety. It rests with the customer to ensure compliance with the prescribed service inspections at all times. Cf. Danish Working Environment Authority Executive Order 1109 §14.

Enjoy your new Raizer!

Best regards,
Liftup A/S

lifting people

"Aesthetics, design and safety is essential in everything we do. We are developing dignified aids, not machines."

LIFTUP A/S
Hagensvej 21
DK-9530 Støvring
Denmark

+45 9686 3020
support@liftup.dk
www.liftup.dk

